

Syntesis® Collection

Syntesis® Collection

SYNTESIS® LINE POCKET DOORS

SYNTESIS® SOCKET POCKETS

SYNTESIS® HINGED

SYNTESIS® SKIRTING



What else can be done with a door and a wall?

Challenge your perceptions with the Eclisse **Syntesis® Collection**

Create unity, unbroken lines, fusion - the perfect background for life to be played out against. A design element you can use to create expression, to reinterpret space, a new way to articulate your environment.

The Syntesis family works anywhere, simplify and unify. In pockets in the wall with sliding doors, in hinged doors with a fine shadow gap and on and around skirting. A modular system to transform your ideas and streamline you space.





/ 01



/ 04

- 01. SYNTESIS® LINE POCKET DOORS
- 02. SYNTESIS® SOCKET POCKETS
- 03. SYNTESIS® HINGED
- 04. SYNTESIS® SKIRTING



SYNTESIS® LINE POCKET DOORS

Syntesis® Line is the Pocket Door system without jambs or architraves. Integrated into the wall, a simpler finish with no extraneous lines.



The innovative edge design allows a seamless plaster finish all around the opening, right up to the edge. A continuous uniform surface means a consistent surface finish, a satisfying fusion of form and function.

/ 01





WHAT MAKES THE SYNTESIS® FRAME SPECIAL



1. Patented Extractable Track.

No need to break into the wall... EVER!
The track and running gear are fully extractable at any time without the need to break into the wall.

2. Fully adjustable front door stop.

For the perfect positioning and closure.

3. Fully adjustable rear doorstop.

The amount the door enters into the pocket can be adjusted easily and simply at any time without removing the door.

4. Supplied with jig/template to make lock.

Install the correct installation of a lock simple and straightforward.

5. Serious Running Gear.

Maintenance free, cannot jump out of track and tested by a completely independent international laboratory to 100,000 cycles of open and close - that's approx. 25 to 30 years of normal everyday use. Guaranteed long lasting, smooth, quiet action. For door panels up to 80 kg.

6. Embossed PVC coated door post.

Prepared for the perfect paint finish.

7. Transparent closing gasket.

Designed to be virtually invisible and to soften the door closure using an integral air cushion system.

8. U Floor Section gives a solid and robust base to the system

ADVANTAGES



9. Crucial strength where it is needed.
Reinforced central structure keeps pocket, track and post all solidly inline...permanently.



11. Sealing Strips.
These paintable sealing strips close off the space between the door and the track and also allow for small differences in tolerance.



14. 90 degree solid steel brackets, strong and secure so the frame keeps its structural integrity.



10. The system has a special rear door bracket which works in conjunction with the self centering, screwless door guide making the door much easier to install.

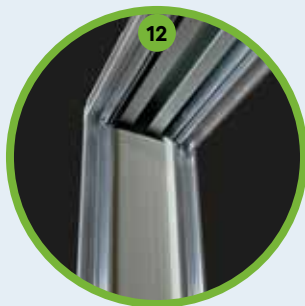

12. Completely Integrated Structure.
The pocket, track holder and door post have an innovative edge design allows a seamless plaster finish all around the opening, right up to the edge.
A continuous uniform surface means a consistent surface finish.



15. Reinforced Horizontal Bars
Made from galvanised steel 0.7 mm thick and formed into a dovetail to reduce to a minimum any distortion in the interior of the pocket.

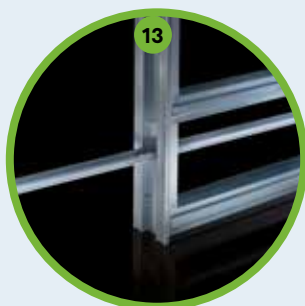

13. Separate Alignment Bar.
The alignment bar maintains a solid link between the frame and the door post during installation making alignment guaranteed during installation.



16. Pocket entrance verticals in extruded aluminium for maximum strength.

SYNTESIS® LINE POCKET DOORS

specification

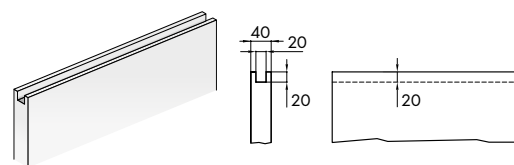
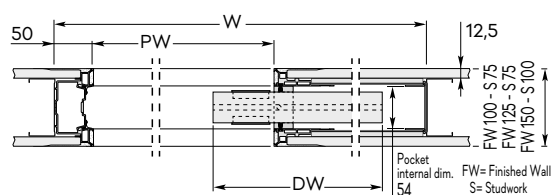
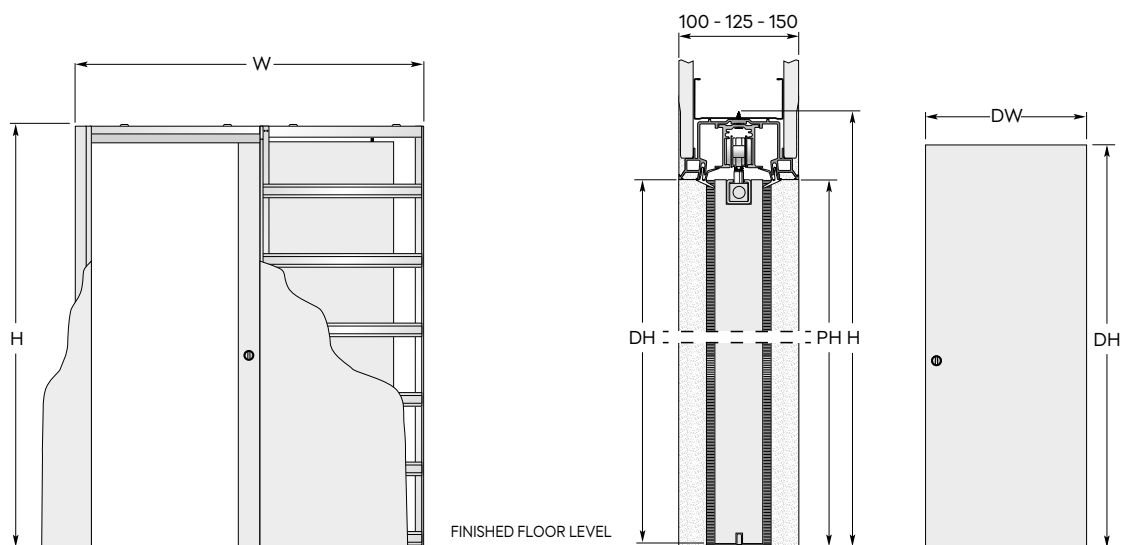

Wooden door panels should be routed as shown along the top edge

| frames for single doors | | | door panel uk | |
|-------------------------|-------------------|----------------|--------------------------------------|------|
| MAX. PASSAGE SIZE | OVERALL DIMENSION | FINISHED WALL | DW | DH |
| PWxPH | WxH | | | |
| 600x2048 | 1385x2108 | 100 -125 - 150 | 626 | 2040 |
| 700x2048 | 1585x2108 | 100 -125 - 150 | 726 | 2040 |
| 800x2048 | 1785x2108 | 100 -125 - 150 | 826 | 2040 |
| 900x2048 | 1985x2108 | 100 -125 - 150 | 926 | 2040 |
| 1000x2048 | 2185x2108 | 100 -125 - 150 | 1026 | 2040 |
| 584x1989 | 1369x2049 | 100 -125 - 150 | 2ft. 0in. x 6ft. 6in. (610 x 1981mm) | |
| 660x1989 | 1545x2049 | 100 -125 - 150 | 2ft. 3in. x 6ft. 6in. (686 x 1981mm) | |
| 736x1989 | 1721x2049 | 100 -125 - 150 | 2ft. 6in. x 6ft. 6in. (762 x 1981mm) | |
| 812x1989 | 1797x2049 | 100 -125 - 150 | 2ft. 9in. x 6ft. 6in. (838 x 1981mm) | |
| 888x1989 | 1973x2049 | 100 -125 - 150 | 3ft. 0in. x 6ft. 6in. (914 x 1981mm) | |

DIMENSIONS ARE GIVEN IN mm

- Available in Non Standard Sizes up to 1300 x 2700 mm passage size.
- Suitable for use with 35 to 44 mm thick doors.
- Max door weight 80 kg.
- 125 and 150 mm finished wall versions require 2 layers of plasterboard per side.
- Passage sizes above 1000 mm wide and above 2150 mm high must be 125 or 150 mm finished wall thickness.
- When fitting flush pull handles we recommend the stop be regulated so the door protrudes from the pocket to avoid risk to fingers.
- Should the door be adjusted to enter the pocket completely we do not accept any liability.
- The framework is not designed to take heavy loads such as radiators e.t.c..
- Doors and plasterboard not supplied.
- Install at finished floor level.
- Anti-Slam device, Eclisse BIAS available separately.

SYNTESIS® LINE POCKET DOORS

specification

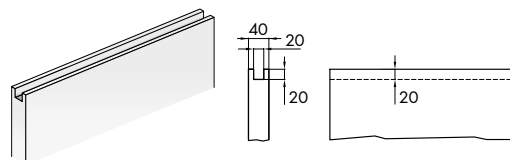
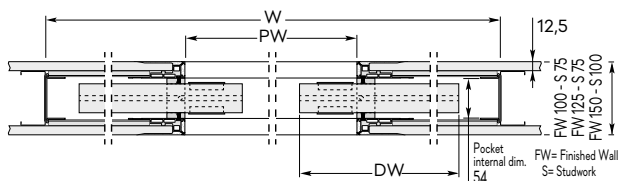
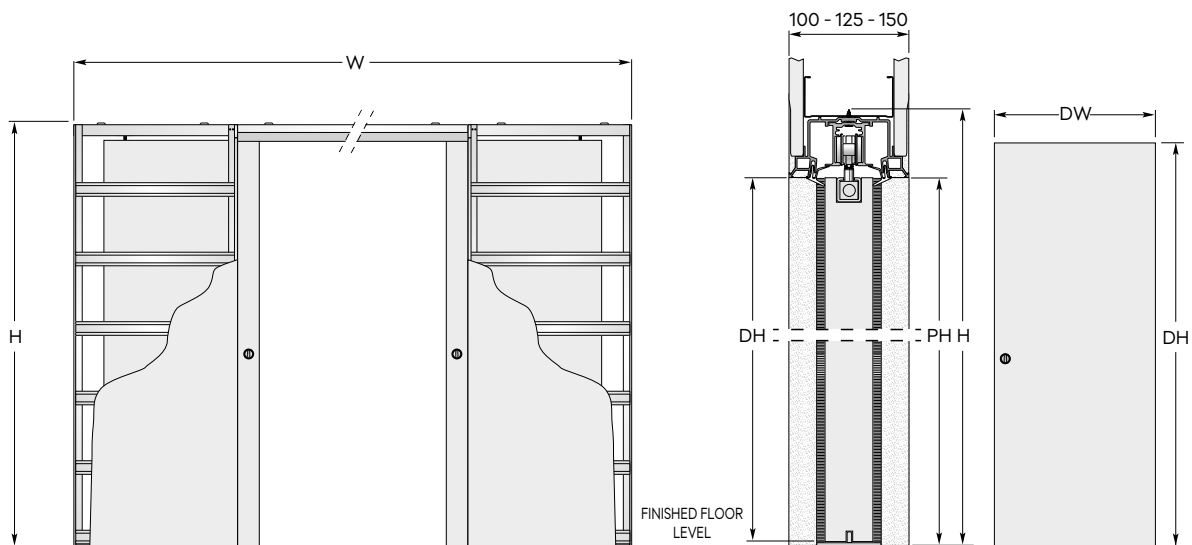

Wooden door panels should be routed as shown along the top edge

| frames for single doors | | | door panel uk | |
|-------------------------|-------------------|---------------|--------------------------------------|------|
| MAX. PASSAGE SIZE | OVERALL DIMENSION | FINISHED WALL | DW | DH |
| PWxPH | WxH | | | |
| 1200x2048 | 2670x2108 | 100-125-150 | 626 | 2040 |
| 1400x2048 | 3070x2108 | 100-125-150 | 726 | 2040 |
| 1600x2048 | 3470x2108 | 100-125-150 | 826 | 2040 |
| 1800x2048 | 3870x2108 | 100-125-150 | 926 | 2040 |
| 2000x2048 | 4270x2108 | 100-125-150 | 1026 | 2040 |
| 1168x1989 | 2638x2049 | 100-125-150 | 2ft. 0in. x 6ft. 6in. (610 x 1981mm) | |
| 1320x1989 | 2990x2049 | 100-125-150 | 2ft. 3in. x 6ft. 6in. (686 x 1981mm) | |
| 1472x1989 | 3342x2049 | 100-125-150 | 2ft. 6in. x 6ft. 6in. (762 x 1981mm) | |
| 1624x1989 | 3494x2049 | 100-125-150 | 2ft. 9in. x 6ft. 6in. (838 x 1981mm) | |
| 1776x1989 | 3846x2049 | 100-125-150 | 3ft. 0in. x 6ft. 6in. (914 x 1981mm) | |

DIMENSIONS ARE GIVEN IN mm

- Available in Non Standard Sizes up to 2600 x 2700 mm passage size.
- Suitable for use with 35 to 44 mm thick doors.
- Max door weight 80 kg.
- 125 and 150 mm finished wall versions require 2 layers of plasterboard per side.
- Passage sizes above 2000 mm wide and above 2150 mm high must be 125 or 150 mm finished wall thickness.
- When fitting flush pull handles we recommend the stop be regulated so the door protrudes from the pocket to avoid risk to fingers.
- Should the door be adjusted to enter the pocket completely we do not accept any liability.
- The framework is not designed to take heavy loads such as radiators e.t.c..
- Doors and plasterboard not supplied.
- Install at finished floor level.
- Anti-Slam device, Eclisse BIAS available separately.



SYNTESIS® SOCKET POCKETS

Syntesis® socket pocket is the pocket door system with a hidden secret. Behind its simple design - no jambs or architraves of course - is a specially constructed pocket frame which will accept your electric sockets easily.



Same continuous surface on the outside, same consistent surface finish. On the inside you can have wiring and back boxes up to 40 mm deep, room for dimmer controls, switches and sockets in the pocket wall.





WHAT MAKES THE SYNTESIS® FRAME SPECIAL



1. Patented Extractable Track.

No need to break into the wall... EVER!
The track and running gear are fully extractable at any time without the need to break into the wall.

2. Fully adjustable front door stop.

For the perfect positioning and closure.

3. Fully adjustable rear doorstep.

The amount the door enters into the pocket can be adjusted easily and simply at any time without removing the door.

4. Supplied with jig/template to make lock.

Install the correct installation of a lock simple and straightforward.

5. Serious Running Gear.

Maintenance free, cannot jump out of track and tested by a completely independent international laboratory to 100,000 cycles of open and close - that's approx. 25 to 30 years of normal everyday use. Guaranteed long lasting, smooth, quiet action. For door panels up to 80 kg.

6. Embossed PVC coated door post.

Prepared for the perfect paint finish.

7. Transparent closing gasket.

Designed to be virtually invisible and to soften the door closure using an integral air cushion system.

8. U Floor Section gives a solid and robust base to the system

9. Reinforced Horizontal Bars.

Made from galvanised steel 0.7 mm thick and formed into a dovetail to reduce to a minimum any distortion in the interior of the pocket.

10. Separate Alignment Bar.

The alignment bar maintains a solid link between the frame and the door post during installation making alignment easy during installation.



ADVANTAGES



11. Crucial strength where it is needed.
Reinforced central structure keeps pocket, track and post all solidly inline...permanently.



13. Sealing Strips.
These paintable sealing strips close off the space between the door and the track and also allow for small differences in tolerance.



15. 90 degree solid steel brackets, strong and secure so the frame keeps its structural integrity.



10. The system has a special rear door bracket which works in conjunction with the self centering, screwless door guide making the door much easier to install.

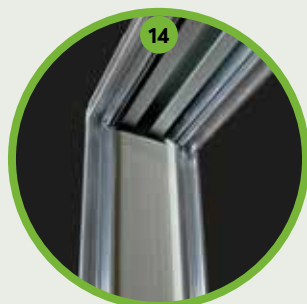

14. Completely Integrated Structure.
The pocket, track holder and door post have an innovative edge design allows a seamless plaster finish all around the opening, right up to the edge. A continuous uniform surface means a consistent surface finish.



16. Pocket entrance verticals in extruded aluminium for maximum strength.

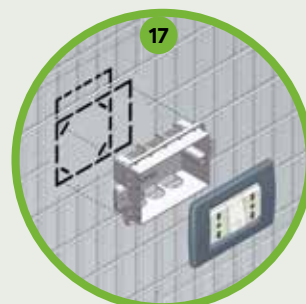

17. The perfect solution when you need a socket, light switch, thermostat etc. in the pocket wall.

SYNTESIS® SOCKET POCKETS

specification

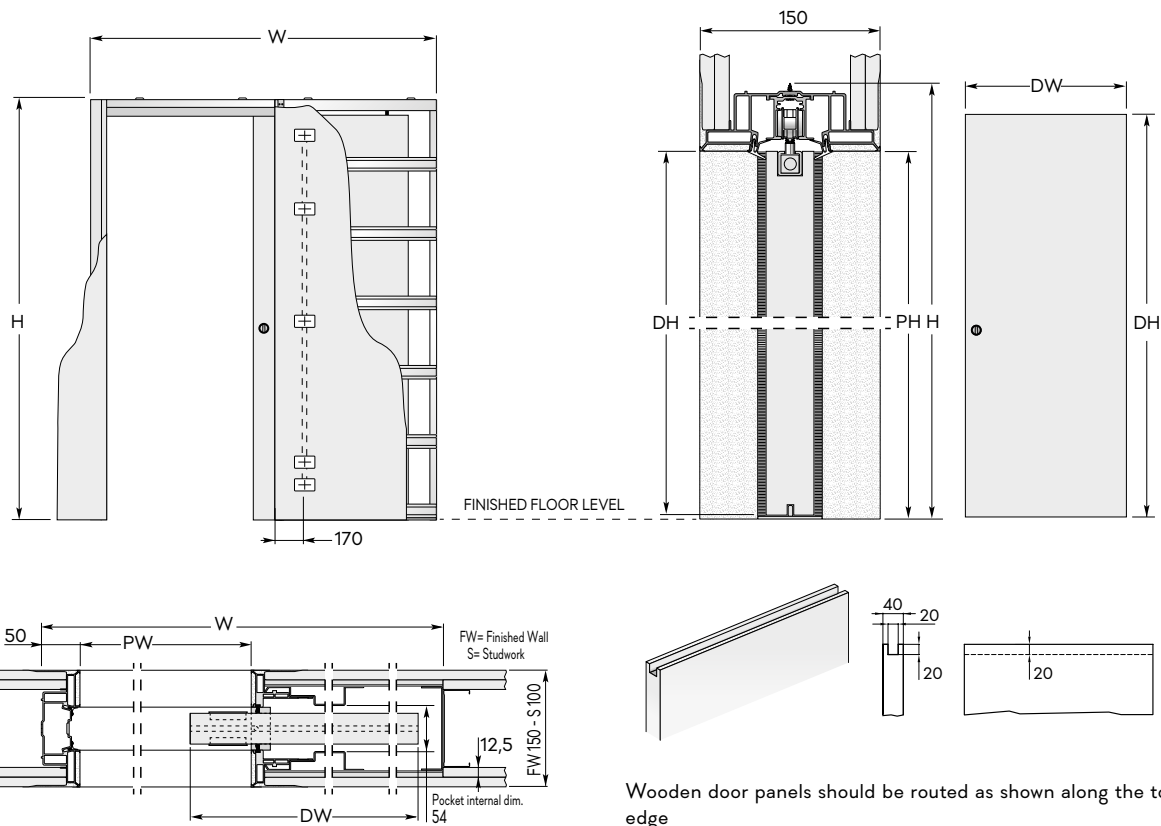

| frames for single doors | | | door panel uk | |
|-------------------------|-------------------|---------------|--------------------------------------|------|
| MAX. PASSAGE SIZE | OVERALL DIMENSION | FINISHED WALL | DW | DH |
| PWxPH | WxH | | | |
| 600x2048 | 1387x2108 | 150 | 626 | 2040 |
| 700x2048 | 1587x2108 | 150 | 726 | 2040 |
| 800x2048 | 1787x2108 | 150 | 826 | 2040 |
| 900x2048 | 1987x2108 | 150 | 926 | 2040 |
| 1000x2048 | 2187x2108 | 150 | 1026 | 2040 |
| 584x1989 | 1371x2049 | 150 | 2ft. 0in. x 6ft. 6in. (610 x 1981mm) | |
| 660x1989 | 1547x2049 | 150 | 2ft. 3in. x 6ft. 6in. (686 x 1981mm) | |
| 736x1989 | 1723x2049 | 150 | 2ft. 6in. x 6ft. 6in. (762 x 1981mm) | |
| 812x1989 | 1799x2049 | 150 | 2ft. 9in. x 6ft. 6in. (838 x 1981mm) | |
| 888x1989 | 1975x2049 | 150 | 3ft. 0in. x 6ft. 6in. (914 x 1981mm) | |

DIMENSIONS ARE GIVEN IN mm

- Available in Non Standard Sizes up to 1300 x 2700 mm passage size.
- Suitable for use with 35 to 44 mm thick doors.
- Back boxes up to 44 mm deep can be installed on each side of the pocket.
- Max door weight 80 kg.
- When fitting flush pull handles we recommend the stop be regulated so the door protrudes from the pocket to avoid risk to fingers.
- Should the door be adjusted to enter the pocket completely we do not accept any liability.
- The framework is not designed to take heavy loads such as radiators e.t.c..
- Doors and plasterboard not supplied.
- Install at finished floor level.
- Anti-Slam device, Eclisse BIAS available separately.

SYNTESIS® SOCKET POCKETS

specification

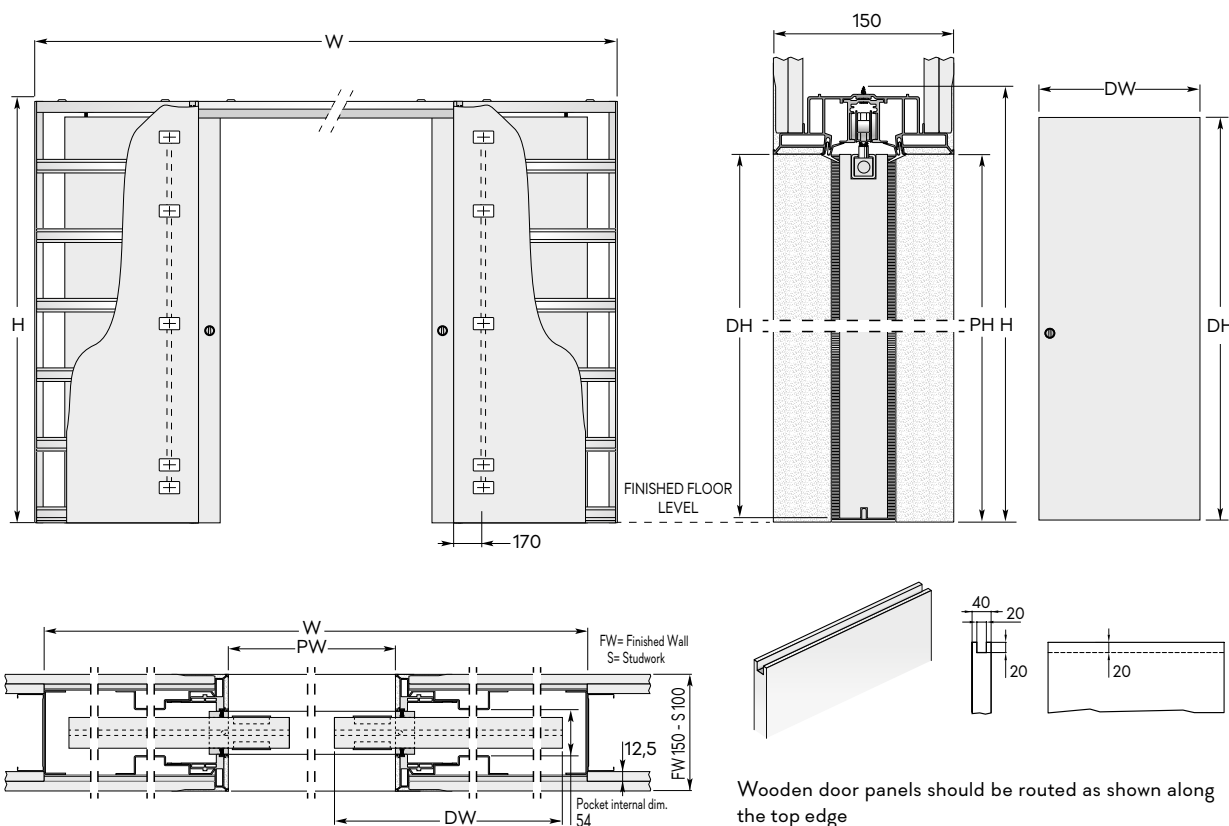

Wooden door panels should be routed as shown along the top edge

| frames for single doors | | | door panel uk | |
|-------------------------|-------------------|---------------|--------------------------------------|------|
| MAX. PASSAGE SIZE | OVERALL DIMENSION | FINISHED WALL | DW | DH |
| PWxPH | WxH | | | |
| 1200x2048 | 2674x2108 | 150 | 626 | 2040 |
| 1400x2048 | 3074x2108 | 150 | 726 | 2040 |
| 1600x2048 | 3474x2108 | 150 | 826 | 2040 |
| 1800x2048 | 3874x2108 | 150 | 926 | 2040 |
| 2000x2048 | 4274x2108 | 150 | 1026 | 2040 |
| 1168x1989 | 2642x2049 | 150 | 2ft. 0in. x 6ft. 6in. (610 x 1981mm) | |
| 1320x1989 | 2994x2049 | 150 | 2ft. 3in. x 6ft. 6in. (686 x 1981mm) | |
| 1472x1989 | 3346x2049 | 150 | 2ft. 6in. x 6ft. 6in. (762 x 1981mm) | |
| 1624x1989 | 3498x2049 | 150 | 2ft. 9in. x 6ft. 6in. (838 x 1981mm) | |
| 1776x1989 | 3850x2049 | 150 | 3ft. 0in. x 6ft. 6in. (914 x 1981mm) | |

DIMENSIONS ARE GIVEN IN mm

- Available in Non Standard Sizes up to 2600 x 2700 mm passage size.
- Suitable for use with 35 to 44 mm thick doors.
- Back boxes up to 44 mm deep can be installed on each side of one pocket as standard, on both pockets upon request.
- Max door weight 80 kg.
- When fitting flush pull handles we recommend the stop be regulated so the door protrudes from the pocket to avoid risk to fingers.
- Should the door be adjusted to enter the pocket completely we do not accept any liability.
- The framework is not designed to take heavy loads such as radiators e.t.c..
- Doors and plasterboard not supplied.
- Install at finished floor level.
- Anti-Slam device, Eclisse BIAS available separately.



SYNTESIS® HINGED

Syntesis® Hinged is the answer to hanging a door flush to the wall, no frame, no jambs, no architraves, just a slender shadow gap.

Paint the door the same colour as the wall, cover the door in the same fabric or paper as the wall and it virtually disappears.



Simple magic.

The door that looks like it's part of the wall, the secret door with nothing to hide.

Sliding or hinged, the Syntesis® range uses the same principles to achieve the same aesthetically appealing finish, the same fusion

of form and function.





WHAT MAKES THE SYNTESIS® FRAME SPECIAL

1. Long lasting and paintable
The aluminium frame is firstly subjected to a phosphate treatment for protection against oxidation, it is then primer coated so it's easy to paint.

2. High strength Frame.
2 kg/m aluminium profile

3. No Plaster Cracking
The frame profile is specially designed to avoid the strains which can cause cracks.

5. Six adjustable ties.
height adjustable for easy installation in a brick wall.

6. Trademark.
It's written on the frame so you know you've got the right kit.

4. OSB 3 Spacer Panel.
Keeps the frame perfectly square during installation.

THE ADVANTAGES:

- Same frame for solid and stud walls;
- Door seal is on the frame, not the door so it is stable, easy to install and good to look at;
- Supplied with plastic protection to avoid on-site scratches etc;
- Hinge protective cover for pull version.



HINGED DOOR



1

1. The door.

Fully primed and ready to paint or lacquer. The door has double thickness stiles and rails improving rigidity.



2

2. The magnetic lock.

Contemporary design and minimal lines; it stays flush and is extra soft when closing.

Eccentric strike plate:

- Minimal design remains flush to frame;
- Allows adjustment to guarantee a perfect closure.

N.B.: Standard can be with or without lock.
Thumb turn on request.

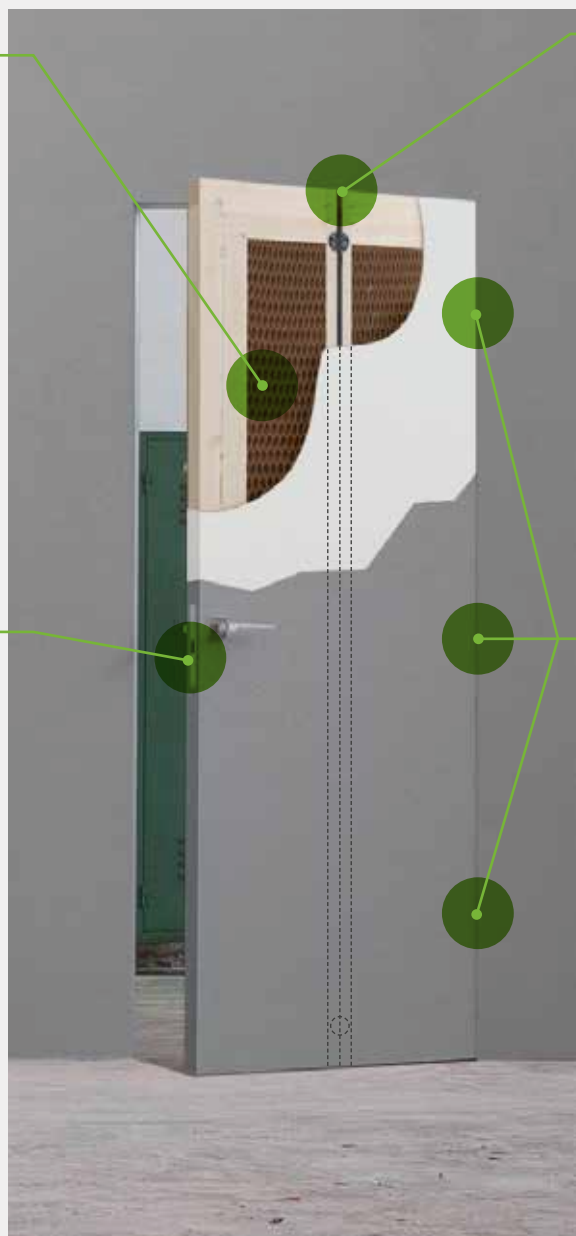

3



3. Tensioning rod*.

A further guarantee of a perfect closure, the tensioning rod ensures the flatness of the door.

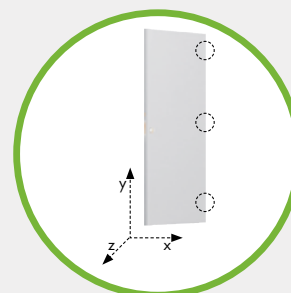

4

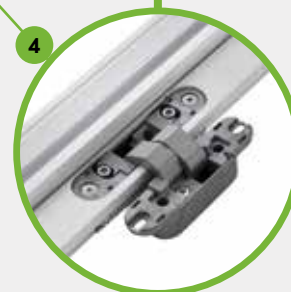

4. Concealed hinges.

3 concealed hinges, all adjustable in 3 axis
N.B.: Doors over 50 kg need 4 hinges

THE DOOR:

- Descreet Eclisse trademark;
- Universal right or left hand opening;
- 45 mm thick;

• all edges are sealed with a border;

* Supplied in heights starting from 2000 mm.



HINGED OPENINGS

CHOOSE THE TYPE OF OPENING



HINGED OPENINGS

PUSH DOOR

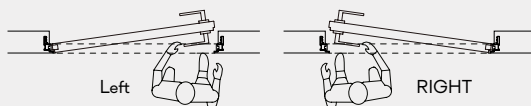

PULL DOOR

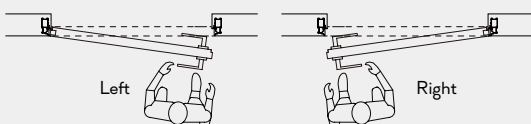

CHOOSE WITH OR WITHOUT TOP RAIL

One of the unusual features of the Eclipse Syntesis® Hinged system is the ability to have it supplied with or without the top rail so when necessary it can be integrated into the ceiling.

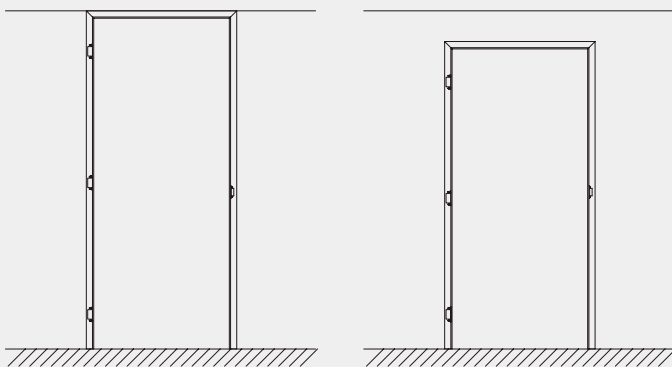

With top rail

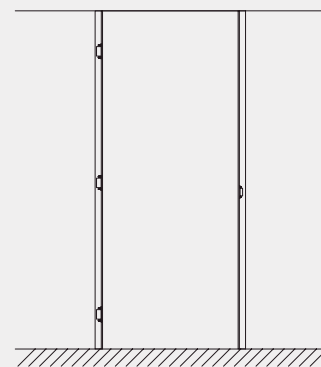

Without top rail



HINGED OPENINGS

CHOOSE THE TYPE OF OPENING - DOUBLE DOORS



HINGED OPENINGS

PUSH DOOR LEFT - RIGHT DOOR FIXED

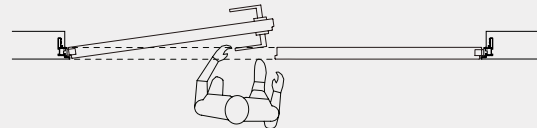

PULL DOOR LEFT - RIGHT DOOR FIXED

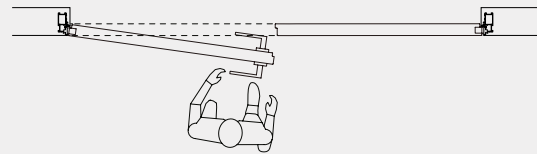

HINGED OPENINGS

PUSH DOOR RIGHT - LEFT DOOR FIXED

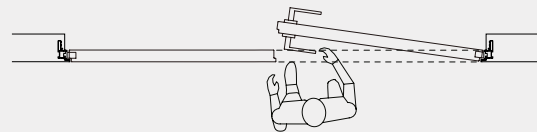

PULL DOOR RIGHT - LEFT DOOR FIXED

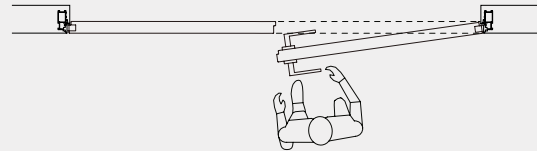

WITH TOP RAIL

Double Syntesis® supplied with Top Rail

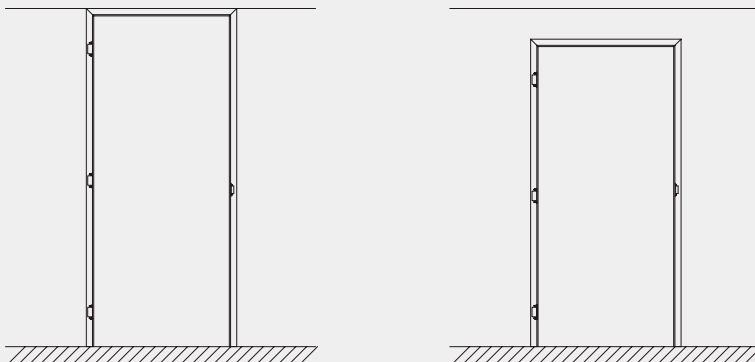

With top rail

Syntesis® double hinged system is supplied with floor and ceiling bolts as standard for the fixed door. If not required this must be specified at time of ordering.

HINGED OPENINGS



SUPPLY POSSIBILITIES



COMPLETE SET

This includes the frame, door and hardware kit

INDIVIDUAL PARTS

ACCESSORIES

HARDWARE KIT



The hardware kit includes the door seal, lock, strike plate, 3 concealed hinges, 3 hinge covers and fixings

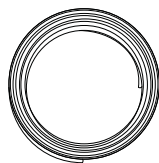

SCHLEGEL AQUAMAC 9111 Door seal, 6,6 m long to be cut to length

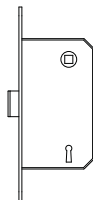

Lock

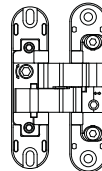

Hinges



Hinge Cover



Strike plate

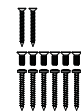

Fixings

DOOR-CLOSER

Completely invisible this door closer comes in 4 variations, left and right and also with or without hold open function. Specify when ordering.

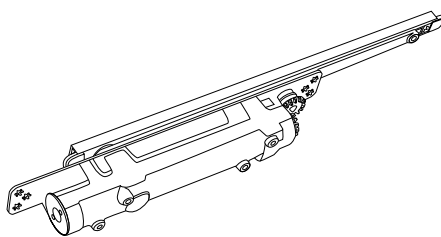

Door-closer

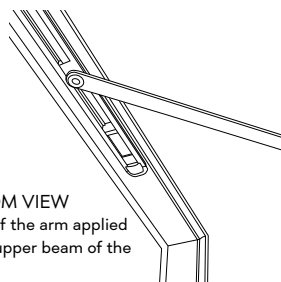

BOTTOM VIEW
Detail of the arm applied on the upper beam of the frame.



VIEW FROM ABOVE
Detail of the door-closer recessed into the door panel

INSTALLATION VARIATIONS

specification

PUSH DOOR

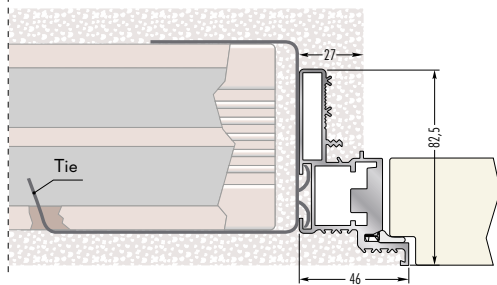

Solid wall

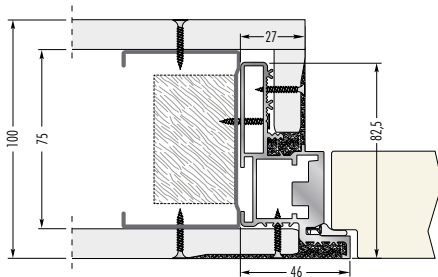

Stud wall with one layer of plasterboard
Finished wall thickness 100 mm

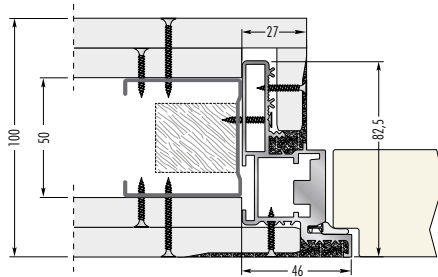

Stud wall with two layers of plasterboard
Finished wall thickness 100 mm

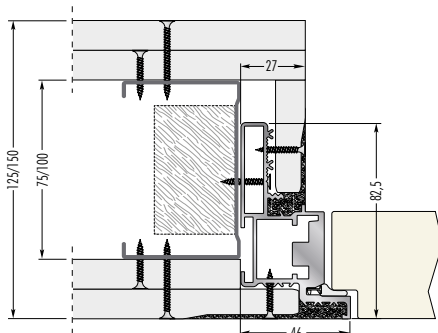

Stud wall with two layers of plasterboard
Finished wall thickness 125/150 mm

PULL DOOR

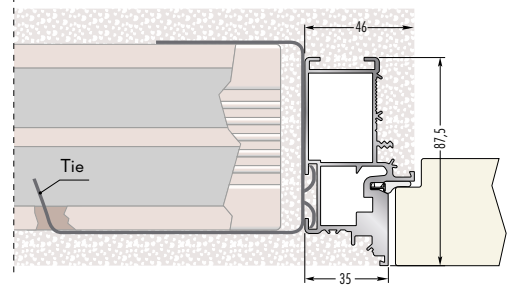

Solid wall

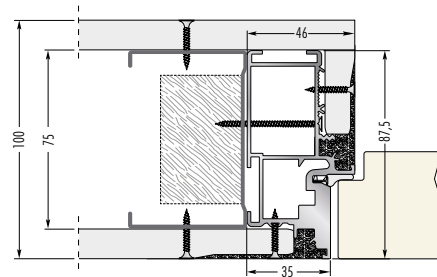

Stud wall with one layer of plasterboard
Finished wall thickness 100 mm

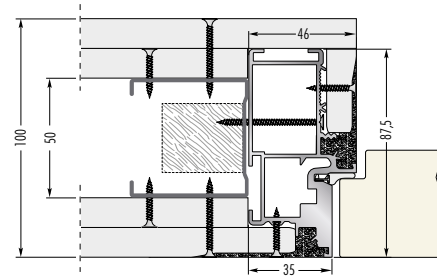

Stud wall with two layers of plasterboard
Finished wall thickness 100 mm

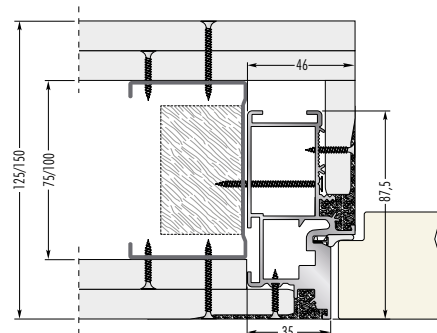

Stud wall with two layers of plasterboard
Finished wall thickness 125/150 mm

The frame is designed for use with solid or stud walls. For solid walls use the 6 adjustable ties to locate the frame, for stud walls screw into the stud through the specifically designed holes.

SYNTESIS® HINGED DIMENSIONS

specification

FRAME WITH TOP RAIL

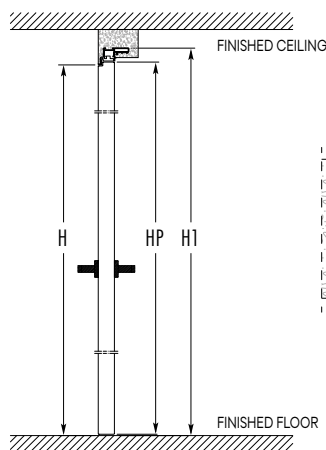

FRAME WITHOUT TOP RAIL

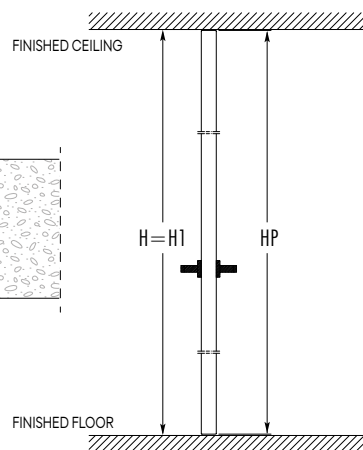

PUSH DOOR

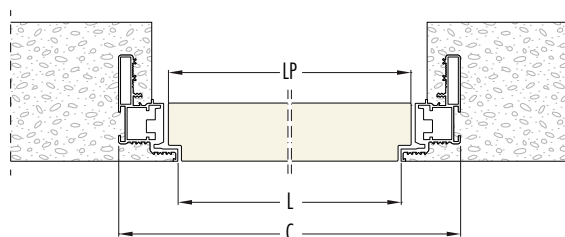

FRAME WITH TOP RAIL

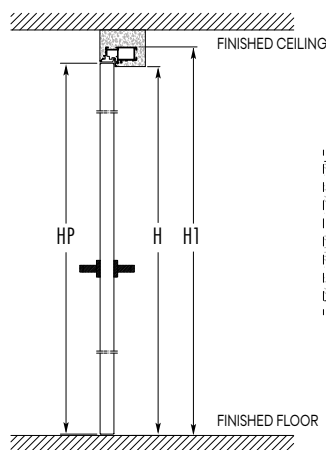

FRAME WITHOUT TOP RAIL

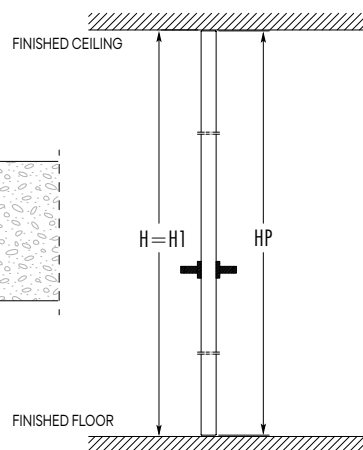

PULL DOOR

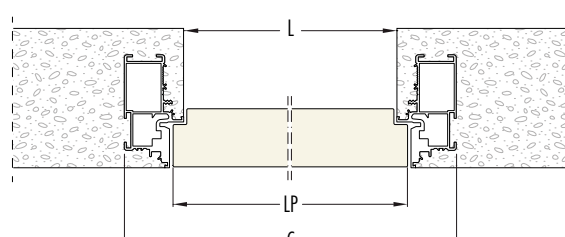

FRAME WITH HEADER

FRAME WITHOUT HEADER

| PASSAGE SIZE | | OVERALL DIMENSIONS | | DOOR PANEL 45 mm thick | | PASSAGE SIZE | | OVERALL DIMENSIONS | | DOOR PANEL 45 mm thick | |
|--------------|-----------|--------------------|-----------|------------------------|-----------|--------------|------|--------------------|------|------------------------|------|
| L | H | C | H1 | LP | HP | L | H | C | H1 | LP | HP |
| 600 | 2100/2400 | 692 | 2146/2446 | 616 | 2104/2404 | 600 | 2700 | 692 | 2700 | 616 | 2693 |
| 650 | 2100/2400 | 742 | 2146/2446 | 666 | 2104/2404 | 650 | 2700 | 742 | 2700 | 666 | 2693 |
| 700 | 2100/2400 | 792 | 2146/2446 | 716 | 2104/2404 | 700 | 2700 | 792 | 2700 | 716 | 2693 |
| 750 | 2100/2400 | 842 | 2146/2446 | 766 | 2104/2404 | 750 | 2700 | 842 | 2700 | 766 | 2693 |
| 800 | 2100/2400 | 892 | 2146/2446 | 816 | 2104/2404 | 800 | 2700 | 892 | 2700 | 816 | 2693 |
| 850 | 2100/2400 | 942 | 2146/2446 | 866 | 2104/2404 | 850 | 2700 | 942 | 2700 | 866 | 2693 |
| 900 | 2100/2400 | 992 | 2146/2446 | 916 | 2104/2404 | 900 | 2700 | 992 | 2700 | 916 | 2693 |
| 950 | 2100/2400 | 1042 | 2146/2446 | 966 | 2104/2404 | 950 | 2700 | 1042 | 2700 | 966 | 2693 |
| 1000 | 2100/2400 | 1092 | 2146/2446 | 1016 | 2104/2404 | 1000 | 2700 | 1092 | 2700 | 1016 | 2693 |

SIZES ARE GIVEN IN mm

• Intervals for height every 50 mm, from 1800 mm to 2700 mm.

• Version with header: height overall dimension is always higher than 46 mm compared to height size H.

• Version with header: it's possible to have a variation with height overall dimension 2700 mm and passage size 2654 mm.

SYNTESIS® LINE BATTENTE APPLICATIONS

specification

FRAME WITH TOP RAIL - PUSH

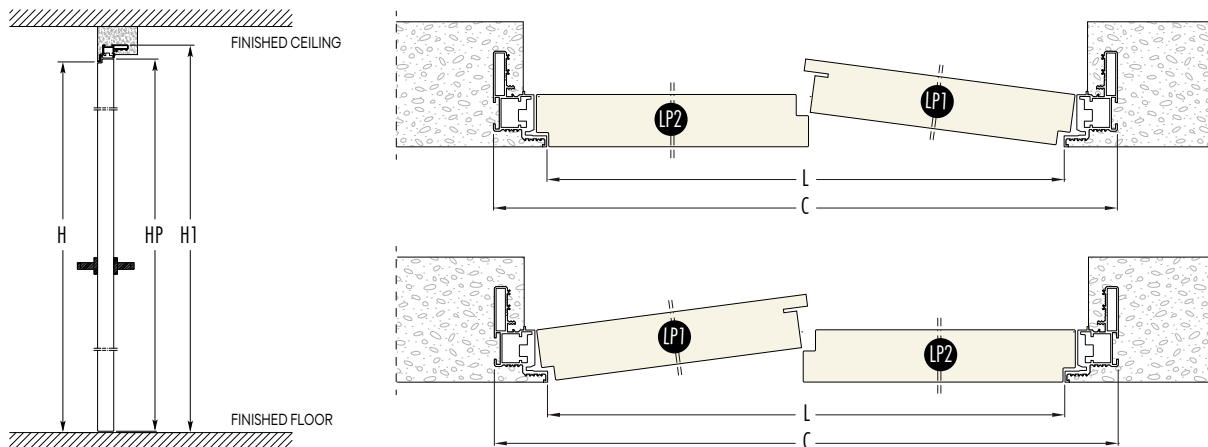

FRAME WITH TOP RAIL - PULL

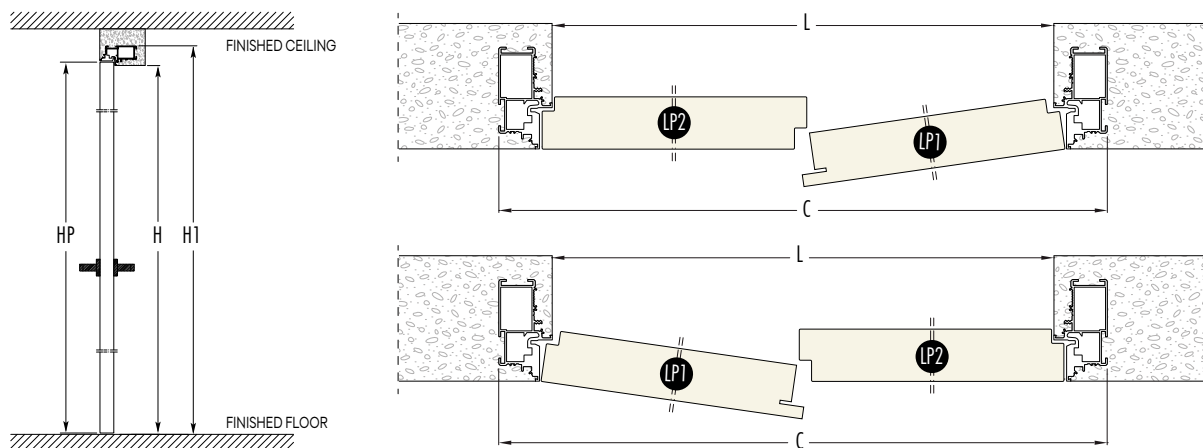

FRAME WITH TOP RAIL

| PASSAGE SIZE | | OVERALL DIMENSIONS | | DOOR PANEL 45 mm thick | | |
|--------------|-----------|--------------------|-----------|------------------------|------|-----------|
| L | H | C | H1 | LP1 | LP2 | HP |
| 1200 | 2100/2400 | 1292 | 2146/2446 | 606 | 616 | 2104/2404 |
| 1300 | 2100/2400 | 1392 | 2146/2446 | 656 | 666 | 2104/2404 |
| 1400 | 2100/2400 | 1492 | 2146/2446 | 706 | 716 | 2104/2404 |
| 1500 | 2100/2400 | 1592 | 2146/2446 | 756 | 766 | 2104/2404 |
| 1600 | 2100/2400 | 1692 | 2146/2446 | 806 | 816 | 2104/2404 |
| 1700 | 2100/2400 | 1792 | 2146/2446 | 856 | 866 | 2104/2404 |
| 1800 | 2100/2400 | 1892 | 2146/2446 | 906 | 916 | 2104/2404 |
| 1900 | 2100/2400 | 1992 | 2146/2446 | 956 | 966 | 2104/2404 |
| 2000 | 2100/2400 | 2092 | 2146/2446 | 1006 | 1016 | 2104/2404 |

MISURE ESPRESSE IN MM

• Intervals for height every 50 mm, from 1800 mm to 2700 mm.

• Height overall dimension is always higher than 46 mm compared to height size H.

• It's possible to have a variation with height overall dimension 2700 mm and passage size 2654 mm.



SYNTHESIS® SKIRTING BOARD ADAPTOR

“The SYNTHESIS® Skirting adaptor means you can have the skirting flush with the wall as well as the doors. An innovative way to define simplicity and elegance. Unlike traditional skirting, this system allows the flush skirting to run all along the wall using either hinged or pocket doors.



Furniture can be placed directly against the wall without adapting the skirting. Eclisse SYNTHESIS® make it possible by providing a special aluminium profile for the wall construction before it is plastered or boarded and before laying the floor.

In perfect harmony with the rest of the SYNTHESIS® collection.

There is even a system which allows the fitment of LED strips into the profile creating a stunning lighting effect.”





SYNTESIS® SKIRTING

TECHNICAL SPECIFICATION

- The profiles are designed for use with 60 mm high skirting but can be installed at a higher level if required.
- The profiles are made from extruded aluminium and have 3 internal chambers which guarantee rigidity and precise joins using the adaptors.
- For solid walls we recommend the fixing using a strong adhesive whilst for stud walls they can be screwed through the pre drilled holes.

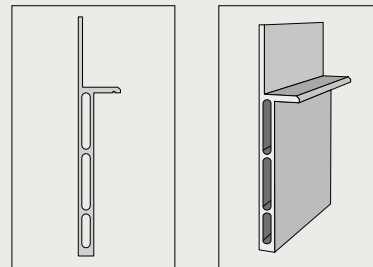

PROFILES

Supplies in 2000 mm lengths
Useful height for skirting 58 mm

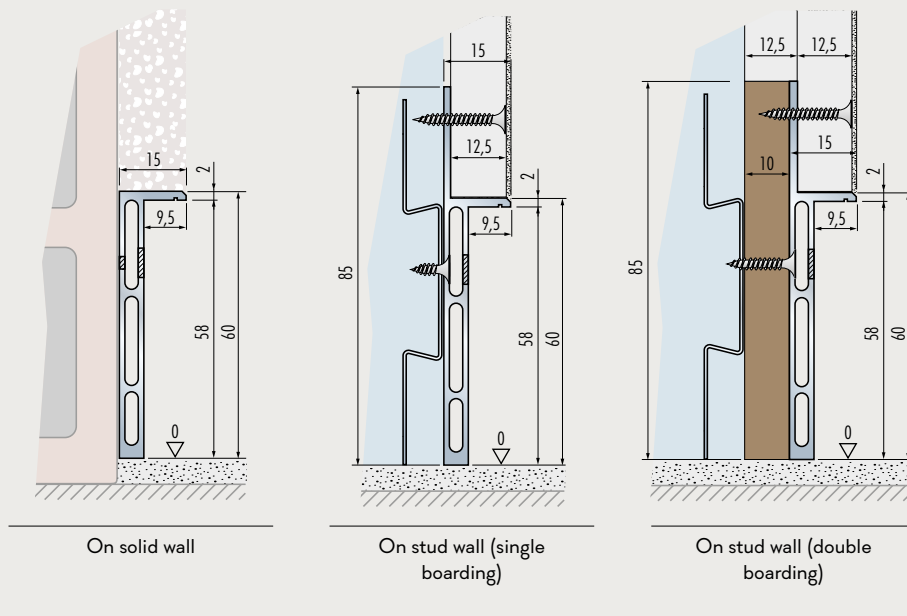

CONNECTORS

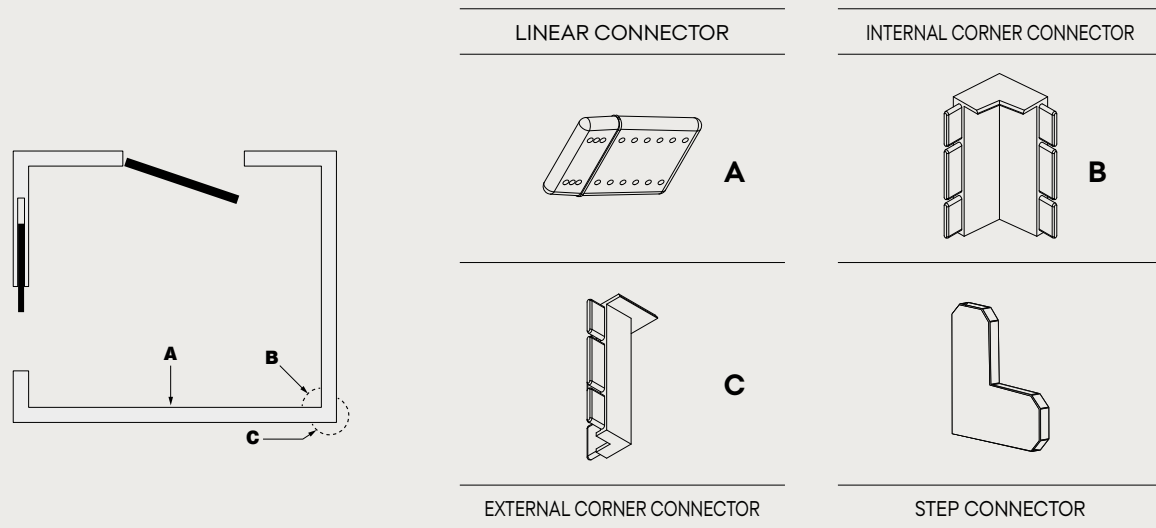



SYNTESIS® SKIRTING

END PROFILES FOR POCKET DOOR SYSTEMS

Each pack contains 4 profiles needed for a single pocket door system

Profiles length 160 mm

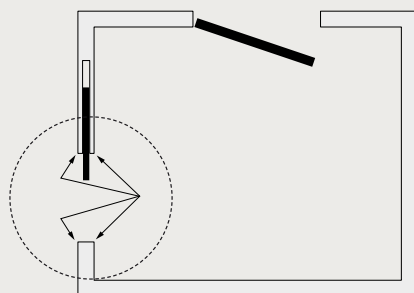

Traditional skirting



SYNTESIS® Skirting

END PROFILES FOR SYNTESIS® HINGES SYSTEMS

Each pack contains 4 profiles needed for each single hinged system

Profiles length 160 mm

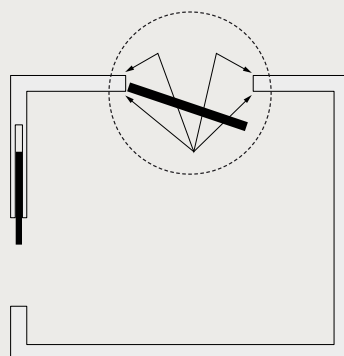

Traditional skirting



SYNTESIS® Skirting

USING LED LIGHTING (LED's not supplied)

Works as a step indicator/illuminator

- The back of the skirting needs to be recessed by 4 mm down 25 mm from the top (see drg);
- fix the LED strip to the rear of the skirting as shown;
- reduce the skirting height by at least 2 mm for light to exit.

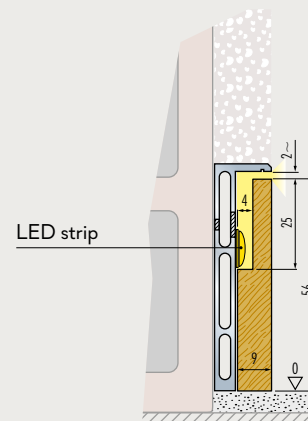



SYNTESIS® PLUS

ECLISSE FRAMELESS GLASS DOORS FOR SYNTESIS POCKET DOOR SYSTEMS



A range of beautiful doors made from tempered 10 mm glass by artisans in a factory near Venice for the most elegant of pocket doors. The bracket along the top protrudes only 25 mm so the final impression is one of a piece of decorated glass sliding into the wall. The standard handle is a glass oblong UV welded to the glass but we have many more options, go to www.eclisse.co.uk

FINISHINGS

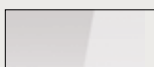

TRASPARENT BASE without sandblasted decorations

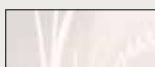

TRASPARENT BASE with sandblasted decorations

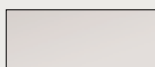

SATIN BASE without sandblasted decorations

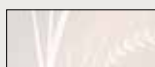

SATIN BASE with sandblasted decorations

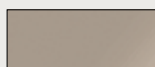

TRASPARENT SMOKED BASE without sandblasted decorations

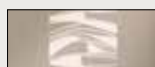

TRASPARENT SMOKED BASE with sandblasted decorations



COLORS

ECLISSE BIAS™

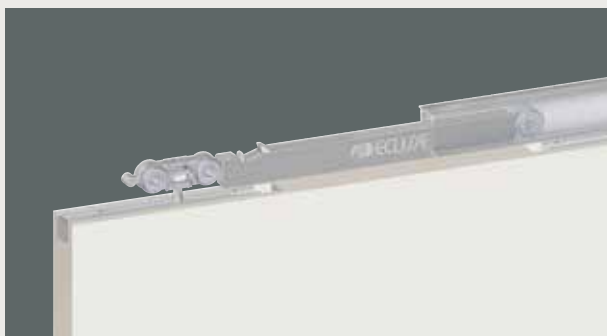

Eclisse BIAS™, Built In Anti Slam
Not just a soft close but a true Anti-Slam device that protects from the door being slammed on fingers by slowing it down in closure. Don't confuse this with a simple soft close, this is a true Anti-Slam device that works.
For SYNTESIS® pocket door systems only.



DOORS

FINISHED OR PRIMED DOORS



You can use your own doors or alternatively we can supply the doors, we are happy to advise you on the types needed however should you wish us to supply the doors they come fully primed ready for your desired finish - same colour as the walls, wallpaper etc. Alternatively we can supply them finished in an opaque off-white RAL 9010.



RAL 9010 OPAQUE PRIMED

HANDLES AND LOCKS



Although you can supply your own handles and locks we can supply magnetic locks for hinged doors and a range of sliding door furniture

CASSIOPEA HINGED

FLUSH DOOR PULLS



HANDLE



HANDLE WITH LOCK AND KEY

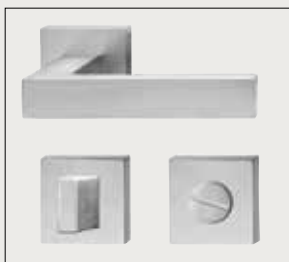

HANDLE WITH BATHROOM THUMB TURN



PUSH-BUTTON DOOR PULLS

CASSIOPEA SLIDING

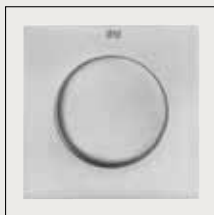

NO LOCK



WITH LOCK AND KEY

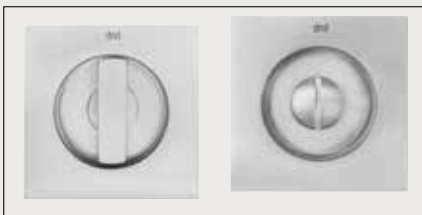

WITH BATHROOM THUMB TURN

SYNTESIS® GALLERY



© ECLISSE, all rights reserved.-The use, filing and total or partial reproduction, using any mechanical or electronic means, of texts, drawings and pictures contained in this publication is strictly prohibited, unless specifically approved in writing by ECLISSE.
All pictures and drawings are for illustrative purposes only. Eclisse s.r.l. reserves the right to make changes in order to improve the product specifications without notice. We may change the content of this catalogue, so if you have any queries related to the products you can contact our call center. Eclisse refuses any responsibility for misprints, clerical errors or for any other reason.

photo
Enrico Dal Zotto

graphic
creativeblend.it

print
Scarpis

601013800
12/2014

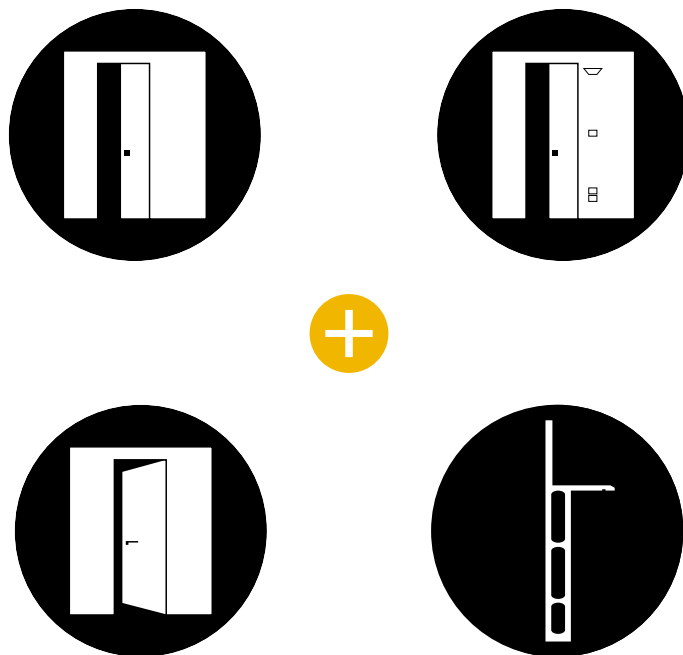

+ SYNTESIS® LINE POCKET DOORS + SYNTESIS® SOCKET POCKETS +
+ SYNTESIS® HINGED + SYNTESIS® SKIRTING +

