

**IT  
COULDN'T  
BE EASIER...  
JUST  
CHOOSE  
ECLISSE**



a sliding Pocket Door system that's SPOT ON!

# NOW YOU CAN USE A POCKET DOOR ALMOST ANYWHERE!

IT COULDN'T BE EASIER...



**STRONG** The strongest of its type on the market

**RELIABLE** Guaranteed 12 years but tested to 25!

**EASY TO FIT** Simple and straightforward to fit using standard materials.

# JUST CHOOSE ECLISSE

DOUBLE



Eclisse make strong, reliable and easy to fit systems that you can use with ANY standard size door, metric or imperial. So use the same doors as the hinged ones.

# JUST HOW EASY ARE THEY TO INSTALL?

*Easy as  
A. B. C....*



**A**



**B**

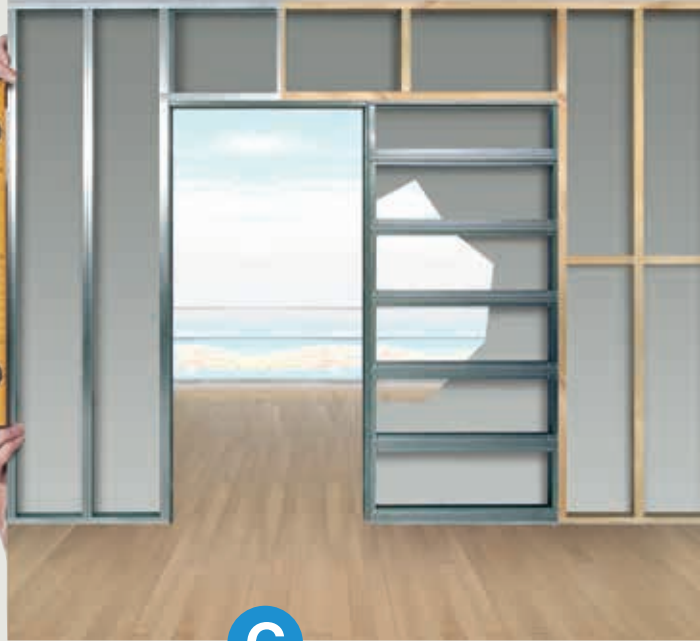

**C**

## STANDARD COMES AS STANDARD!

use **STANDARD** doors, metric or imperial

use **STANDARD** door thicknesses 35 or 44 mm

use **STANDARD** 12.5 mm plasterboard (we even supply the screws!)

use **STANDARD** stud work, metal or wood, for 100 mm or 125 mm finished walls

**THE ONLY THING SPECIAL IS THE  
ECLISSE SYSTEM ITSELF!**

# THE ORDER OF WORK

With the stud work ready...

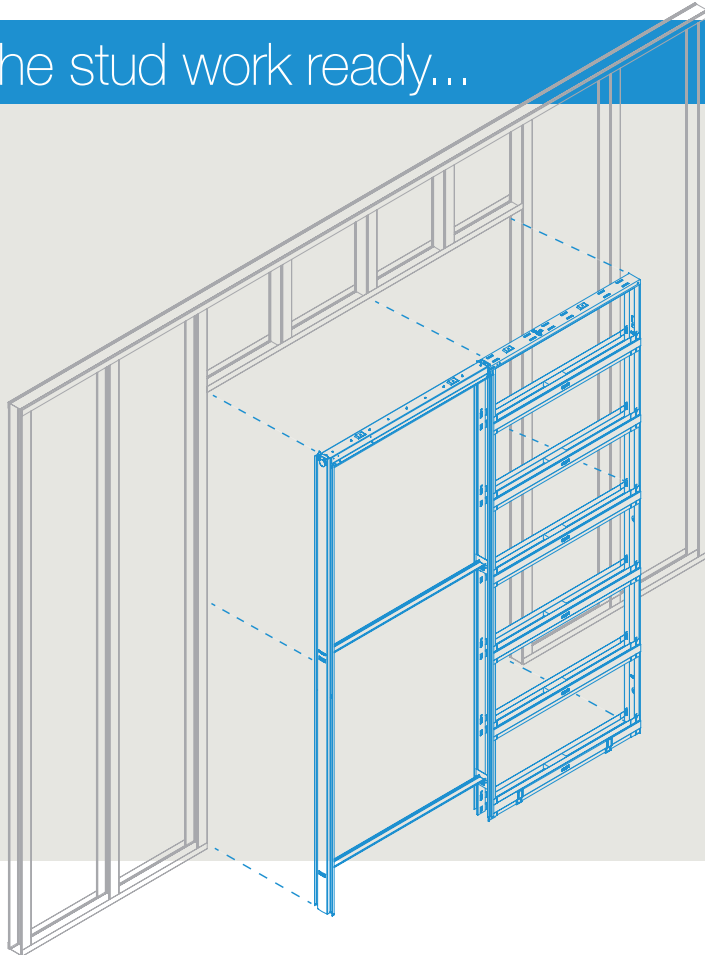

1.	ASSEMBLE THE FRAME	15 minutes
2.	SCREW FRAME INTO THE STUDWORK	15 minutes
3.	FIT THE DOOR (TWO BRACKETS AND A PROFILE)	15 minutes
4.	FIT JAMBS	45 minutes

You can fit the plasterboard at anytime after the frame installation.

## THAT'S IT !

A COUPLE OF HOURS AND YOU HAVE A BEAUTIFUL POCKET DOOR, CREATED A LOT MORE USABLE SPACE AND YOU HAVE THE BEST POSSIBLE RESULT - GUARANTEED !

# HOW TO SIZE A POCKET DOOR SYSTEM

## SINGLE



### CHOOSE EITHER

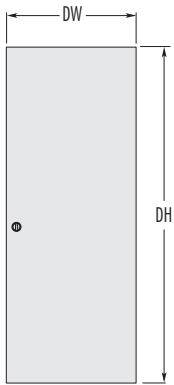

DOOR SIZE	PASSAGE SIZE	FRAME SIZE
STANDARD DW x DH	STANDARD PW x PH	STANDARD W x H
2ft. 0in. x 6ft. 6in. (610 x 1981mm)	= 585 x 1971 mm	1273 x 2056 mm
2ft. 3in. x 6ft. 6in. (686 x 1981mm)	= 661 x 1971 mm	1449 x 2056 mm
2ft. 6in. x 6ft. 6in. (762 x 1981mm)	= 737 x 1971 mm	1625 x 2056 mm
2ft. 9in. x 6ft. 6in. (838 x 1981mm)	= 813 x 1971 mm	1701 x 2056 mm
3ft. 0in. x 6ft. 6in. (914 x 1981mm)	= 900 x 1971 mm	1888 x 2056 mm
626 x 2040 mm	= 600 x 2030 mm	1288 x 2115 mm
726 x 2040 mm	= 700 x 2030 mm	1488 x 2115 mm
826 x 2040 mm	= 800 x 2030 mm	1688 x 2115 mm
926 x 2040 mm	= 900 x 2030 mm	1888 x 2115 mm
1026 x 2040 mm	= 1000 x 2030 mm	2088 x 2115 mm

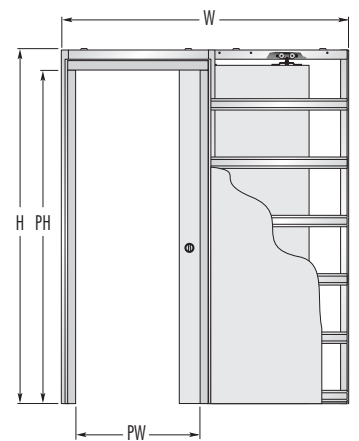

THEN CHOOSE THE FINISHED WALL  
THICKNESS - 100 mm OR 125 mm.

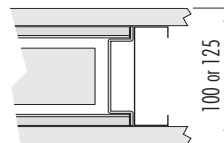

## FD30 APPROVED SYSTEM?



# DOUBLE DOORS? NO PROBLEM

## DOUBLE



### CHOOSE EITHER

	DOOR SIZE	PASSAGE SIZE	FRAME SIZE	
	STANDARD DW x DH	STANDARD PW x PH	STANDARD W x H	
	2ft. 0in. x 6ft. 6in. (610 x 1981mm)	= 1170 x 1971 mm	2464 x 2056 mm	
	2ft. 3in. x 6ft. 6in. (686 x 1981mm)	= 1322 x 1971 mm	2816 x 2056 mm	
	2ft. 6in. x 6ft. 6in. (762 x 1981mm)	= 1474 x 1971 mm	3168 x 2056 mm	
	2ft. 9in. x 6ft. 6in. (838 x 1981mm)	= 1626 x 1971 mm	3320 x 2056 mm	
	3ft. 0in. x 6ft. 6in. (914 x 1981mm)	= 1800 x 1971 mm	3694 x 2056 mm	
	626 x 2040 mm	= 1200 x 2030 mm	2494 x 2115 mm	
	726 x 2040 mm	= 1400 x 2030 mm	2894 x 2115 mm	
	826 x 2040 mm	= 1600 x 2030 mm	3294 x 2115 mm	
	926 x 2040 mm	= 1800 x 2030 mm	3694 x 2115 mm	
	1026 x 2040 mm	= 2000 x 2030 mm	4094 x 2115 mm	

THEN CHOOSE THE FINISHED WALL  
THICKNESS - 100 mm OR 125 mm.

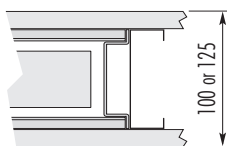

## NO PROBLEM

We have a **single system** fully approved for use with **FD30 Fire doors** (44 mm). The frames are the same as the standard singles on the previous page but the jambs and architraves are special. Passage sizes are slightly reduced by 20 mm in height and 30 mm in width. 100 mm finished wall thickness. You will need 15 x 4 mm intumescents for this unit.

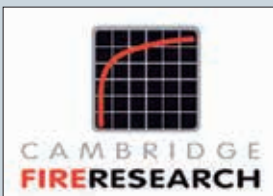

**INTERNATIONAL FIRE  
CONSULTANTS LTD**

The system was tested to BS EN 1634-1:2008 for fire resistance at Cambridge Fire Research which is an independent UKAS accredited testing laboratory.

# NOT ALL POCKET DOOR SYSTEMS ARE THE SAME!

## USE WOOD OR METAL STUD



**LIGHT AND MANAGEABLE**  
You don't need a fork lift to carry it!

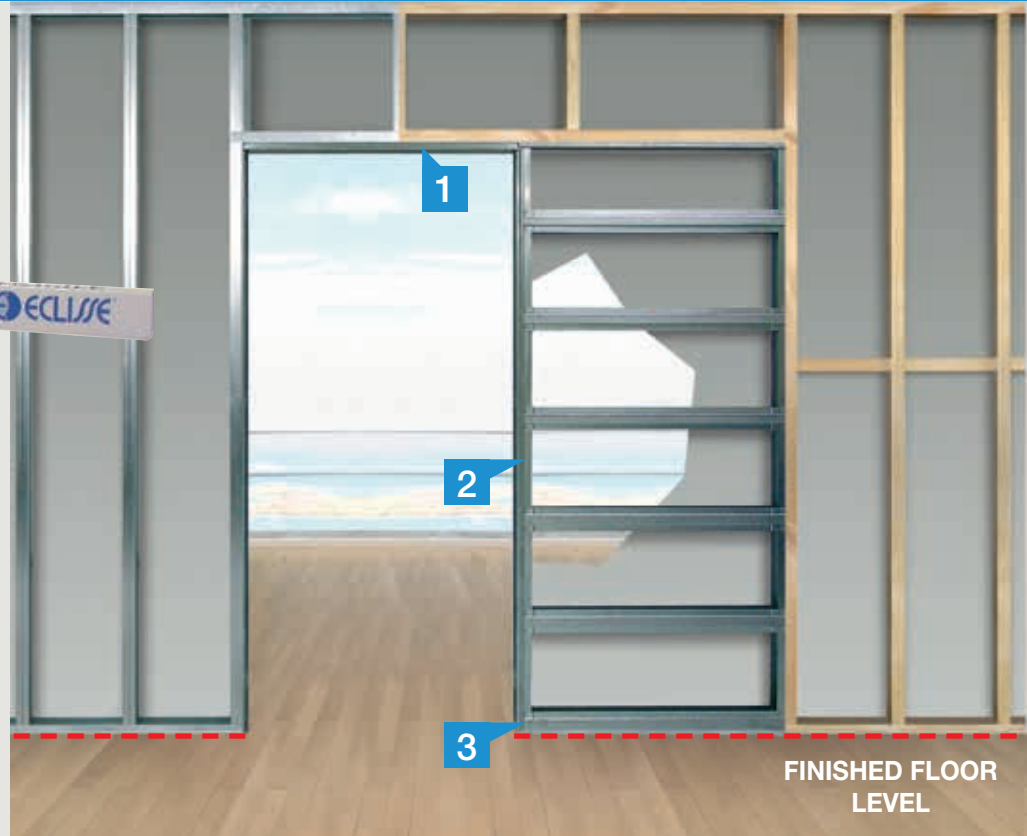

**1 PEACE OF MIND**  
The track can be completely removed at any time without breaking into the wall.



**2 THEY NEED TO BE STRONG**  
1.2 mm galvanised steel specially formed into super strong profiles.



**3 DOOR GUIDE CENTRES ITSELF**  
Self-centering door guide, quick and easy to fit.





# ECLISSE DETAILS MAKE THE DIFFERENCE

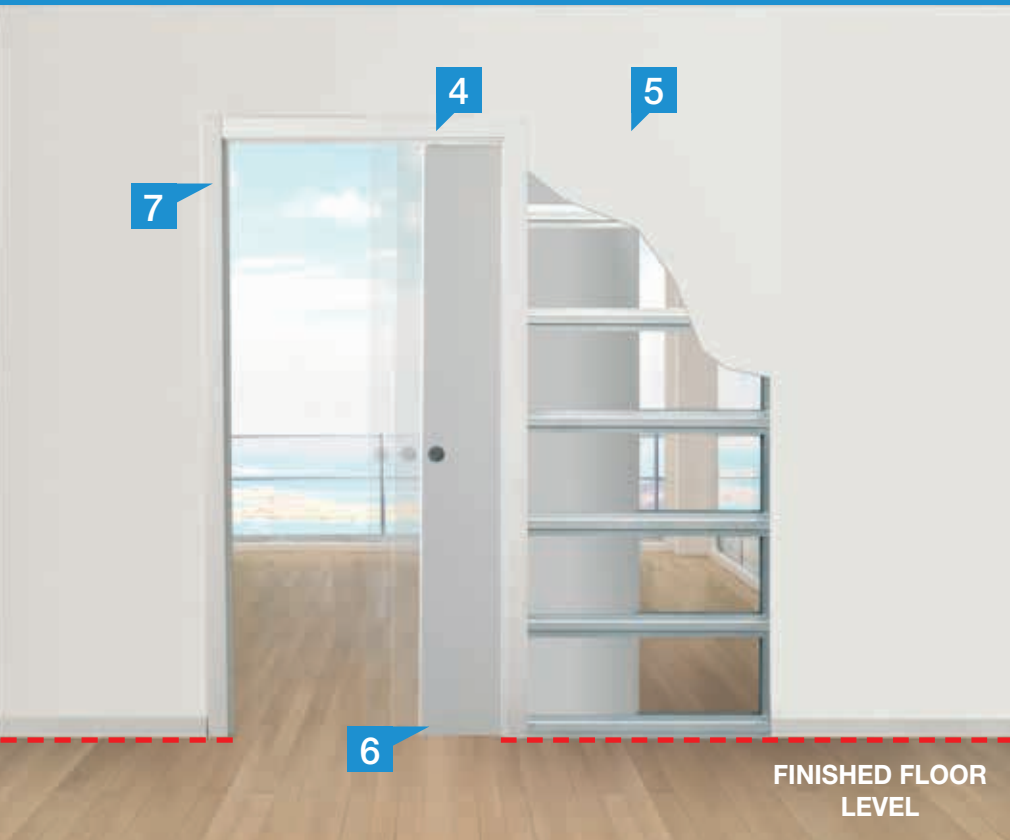

## FULL FSC TIMBER LINING (JAMB) KIT

Eclisse designed real wood lining kit with dust brushes, rubber bumpers and a recessed door post. FSC certified. A really professional finish.



## SEALED FOR LIFE, MAINTENANCE FREE

Runners are enclosed inside the track and can't jump out. They're maintenance free too - tested to 100,000 cycles.

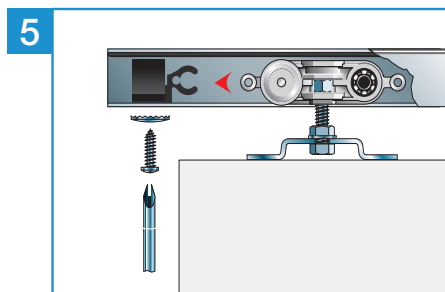

## DOORSTOPS FRONT AND REAR

The position of the door can be adjusted at any time. The door stops and is held in place by small clamps so the door stays shut.

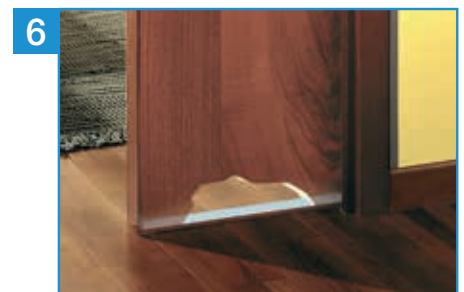

## DOORS DO WARP!

But our anti-warp profile means the action remains smooth.

# THE JAMB KIT

DON'T SKIP THIS PAGE - IT IS IMPORTANT

**NOT ALL SUPPLIERS GO TO THESE LENGTHS FOR THE PERFECT FINISH!**

**FINISHED WALL THICKNESS  
100 OR 125 MM**

## A PROFESSIONAL FINISH

We could have left it at that - a brilliant steel sliding pocket door system.. but the finished article is extremely important to customer satisfaction so rather than leaving it to chance we designed our own timber lining kit (jambs) which we supply AS STANDARD with all our relevant single and double units.

## NOT JUST ANY PIECE OF WOOD

Finger jointed fir for long term stability and a naturally attractive fine grain. Also available with a real wood cherry walnut veneer which is a light, mid range veneer that is unfinished so it can be painted or stained.

## DESIGN DETAILS

Why do we go to all the trouble to produce a recessed wooden door post? Well if you think about it, a flat door post would not guarantee a perfect shut line between the door and the post however a recessed post allows the door to enter into the post so creating a perfect shut line. We also include rubber bumpers to insert into the corners of the recess so the door doesn't bang against wood every time it closes!

To cope with both 35 mm and 44 mm thick doors we include two sets of brushes 15 mm and 10 mm so they always give you the perfect finish.

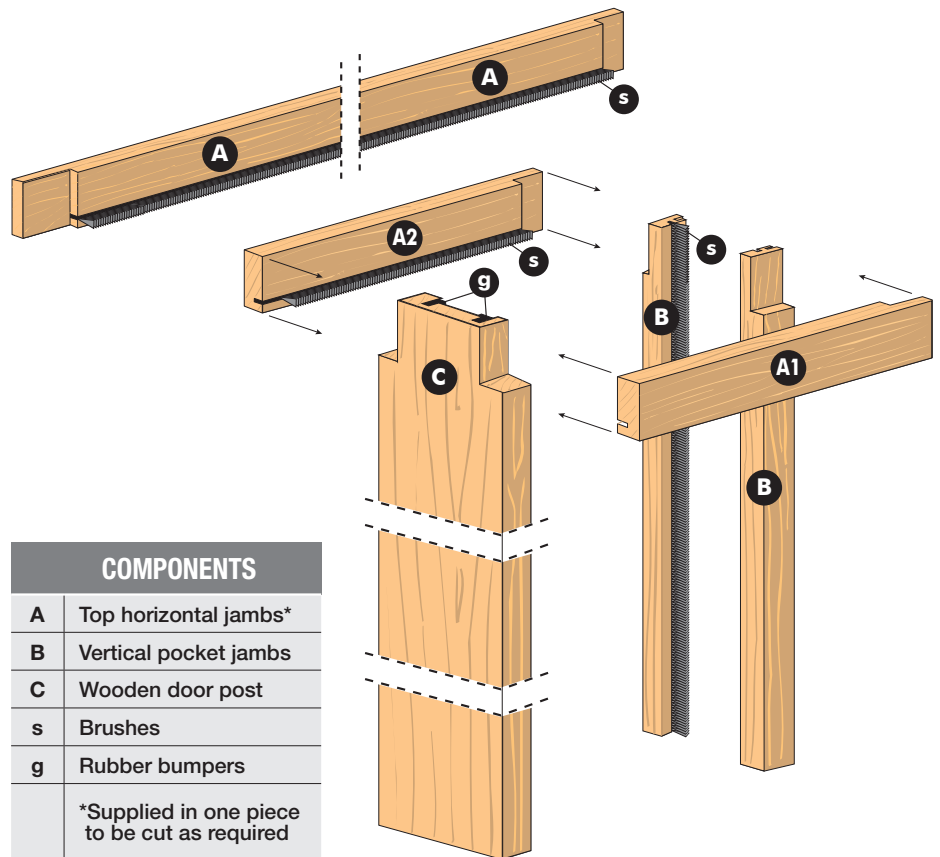

COMPONENTS	
A	Top horizontal jambs*
B	Vertical pocket jambs
C	Wooden door post
s	Brushes
g	Rubber bumpers
*Supplied in one piece to be cut as required	

## STD JAMBS FOR SINGLE DOORS

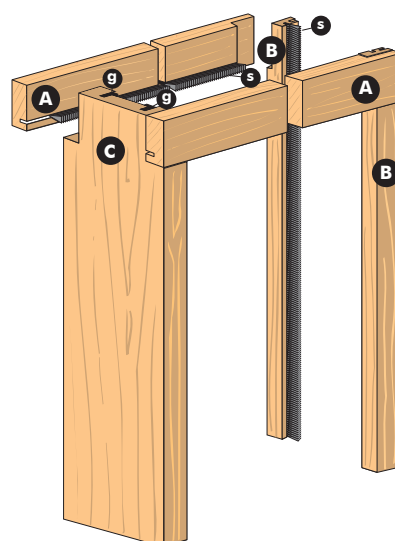

## STD JAMBS FOR DOUBLE DOORS

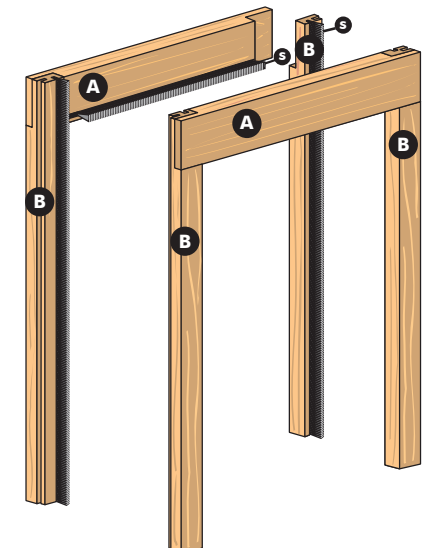

**FOR FIRE JAMBS SEE  
ECLISSE.CO.UK**

# OTHER TYPES OF

## ECLISSE POCKET DOOR SYSTEMS



### CURVED

Continue the curve and create architecturally sophisticated designs of movement and shape. Make a spectacular entrance or exit with this stunning feature. Doors supplied.



### NOVANTA

The little genius of the Eclisse range, half of the door slides into the wall and half of the door folds back discreetly. For when there just isn't enough space for an extra downstairs cloakroom or a laundry off the kitchen, it can be done with Novanta - the perfect little loo door.



### TELESCOPIC

Telescopic frame allows two door panels to go into the same wall giving the widest opening and light for the shortest wall space.

A synchronized system is also available and allows the two doors to slide into the frame smoothly and simultaneously. Maximise the opening, reduce the wall space needed.



### UNILATERAL

Unilateral perfect for narrow hallways and corridors where wall space is short but you have to have doors. The Unilateral uses only one wall pocket but with two doors!

# SLIDING DOOR FURNITURE

## SIMPLE FLUSH PULLS



Designed for single sliding doors where locking is not important. Supplied with finger pull for use in the leading edge of door. Order two sets for double doors. Dimensions: Outer Diameter 57 mm, Internal diameter 47 mm.

### ROUND

Polished brass	<b>OSO8</b>
Antique brass	<b>OSC4</b>
Polished chrome	<b>OSC2</b>
Satin chrome	<b>OSC1</b>
Black painted brass	<b>OSA5</b>



OSO8



OSC4



OSC2



OSC1



OSA5

### SQUARE

Polished brass	<b>OSC2Q</b>
Satin chrome	<b>OSC1Q</b>



OSC2Q



OSC1Q

### SIMPLE FLUSH PULLS KIT

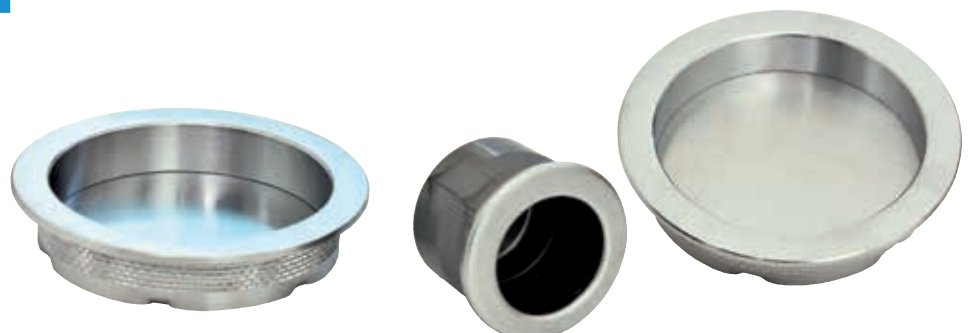

# BATHROOM LOCKS



Specifically designed for use with bathroom/wc. These locks have internal thumb turn and external emergency opening. Also included is a finger pull for use in the leading edge of door. Available for 35mm or 44mm doors. Please specify when ordering. Dimensions: Outer Diameter 57 mm, Internal diameter 47 mm.

## ROUND

Polished brass	OSO3
Antique brass	OSA
Polished chrome	OSO1
Satin chrome	OSS
Black painted brass	OSA1



OSO8



OSC4



OSC2



OSC1



OSA5

## SQUARE

Polished brass	OSO1Q
Satin chrome	OSQ



OSC2Q



OSC1Q

## COMPLETE BATHROOM KIT



Patent - self-aligner

# PARIS

## SURFACE MOUNTED SLIDING SYSTEM

WHEN A POCKET DOOR SYSTEM WON'T FIT

### PARIS 1



**Contents:**

2 m. Eclisse running track;  
80 kg sealed for life  
runners; Runner stops;  
Door guide;  
Wall brackets.

### PARIS 2



**Contents:**

2 m. Eclisse running track;  
80 kg sealed for life  
runners; Runner stops;  
Door guide;  
Wall brackets;  
**PLUS** wooden track  
mount;  
Pelmet with brackets;  
Pelmet ends.

### PARIS 3



**Contents:**

2 m. Eclisse running track;  
80kg sealed for life  
runners; Runner stops;  
Door guide;  
Wall brackets;  
Wooden track mount;  
Pelmet with brackets;  
Pelmet ends;  
**PLUS** 2.1 m. door post.

**TAKE YOUR PICK!  
THERE'S ONE FOR  
EVERY SITUATION**

Mounting screws not included as we don't know what type of wall you will be using.

All wood is in a cherry walnut veneer, paint or stain ready, door not supplied. Can be used with soft close accessory.

# POCKET DOOR

## ACCESSORIES

### SOFT CLOSE

Just like your kitchen cabinets, you push the door and leave the final closing to the soft close device - softly and quietly.

There is the additional advantage that it protects from trapped fingers too. We have three types, for doors up to 40 kg, doors from 40 to 50 kg and a separate unit for use with our self close system.

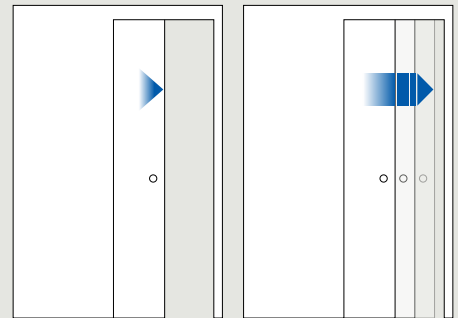

### SELF CLOSE

You open the door and it closes itself, it is that simple. Working on a system of springs completely hidden from view behind the wooden door post this system is ideal for bathrooms, utilities etc.

The closing speed can be adjusted manually.

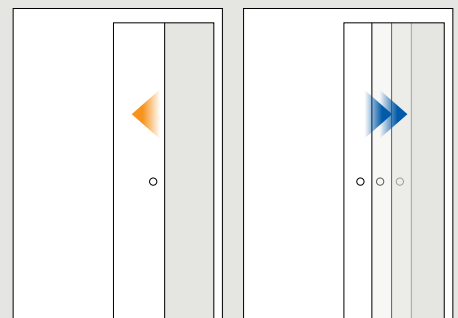
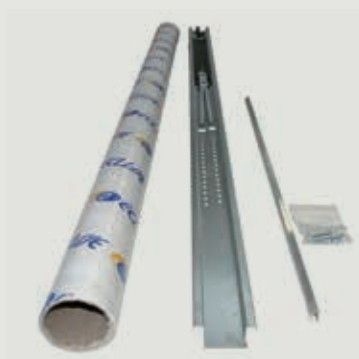

### DOUBLE DOOR CO-ORDINATION

This is a neat and simple system for closing double doors.

They're connected by special cables so that when you close one door the other closes and vice versa... we also include a soft close unit with this accessory to give the \*StarTrek effect but without the noise, just one push of one door and the soft close takes over towards the end of its travel and closes the doors softly and quietly. Although when using doors heavier than 25 kg each complete closure of the doors cannot be guaranteed.

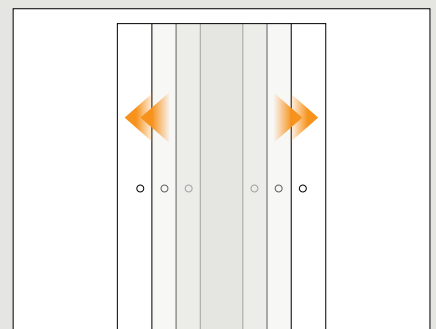

# GLASS POCKET DOORS



## Let The Sun Shine In!

Don't just use these systems for your en-suite... let light and space into any area, between living and dining, into the kitchen, utility... virtually any area will be more beautiful with sliding pocket glass doors.

With a wide range of designs and motifs available including hand painted by Italian artists and with the option of your own customized design the possibilities are endless.

Make a statement, make some more space, make a brighter place to live!

Here are just a few examples, we have lots more, see:

[eclisse.co.uk/Karis-Glass-Doors](http://eclisse.co.uk/Karis-Glass-Doors)

SATIN



RIFLESSI



RIGHE 1



SPACE AGE



VALENTINA





# ECLISSE AND GLASS THE PERFECT MATCH!

ROSA PESCO



NEBBIA



DOUBLE DOORS TOO



PUPA



OBLIO



BRIO



TRAMONTO



STARGATE

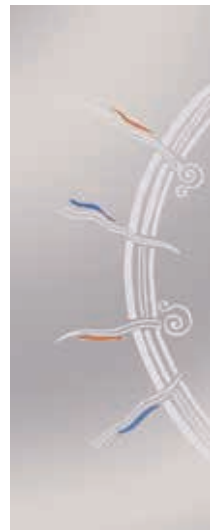

OBLIQUO



GARDEN



NINFE



COLOUR



COLOUR

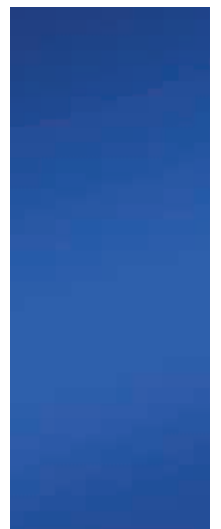

# GOT A QUESTION



## FRAME?



**Q. DO ECLISSE FRAMES COME SUPPLIED WITH THE DOORS?**

A. No, you can use any standard door you like, we have a frame for each size. We do however supply frameless glass doors.

**Q. WHAT ARE THE LIMITS ON THE DOOR SIZES?**

A. The standard range of frames fit all standard door sizes however non-standard sizes can be manufactured up to 2 m. wide and 2.9 m. high to order.

**Q. DO I NEED A THRESHOLD?**

A. No the floor surface remains uninterrupted, you can continue it through the doorway.

**Q. DO YOU OFFER INSTALLATION?**

A. No, we supply only because these are relatively easy to assemble and install by Builders, Joiners or even competent DIYers.

**Q. WHAT GUARANTEE DO YOU OFFER?**

A. We offer a 12 year guarantee against faulty materials or workmanship for the frame.

## JAMBS?



**Q. ARE THERE DIFFERENT JAMBS FOR DIFFERENT FRAMES?**

A. Jamb kits depend on the finished wall thickness, always specify this when ordering.

**Q. WHAT MATERIALS ARE THEY MADE OF?**

A. They are made of finger-jointed pine with a real wood (cherry walnut) veneer, or fir and are ready for painting or staining.

**Q. WHY DO WE USE BRUSHES AROUND THE DOOR?**

A. Modern doors can warp so the brushes are used not only to seal off the pocket etc but to take any door warping into account.

**Q. SO WHO NEEDS A WOODEN DOOR POST?**

A. Recessed door post will let your door slide right into it giving you a perfect closure line; and it gives space to insert tiny rubber bumpers to soften closing noise.

## GLASS DOORS?



**Q. IS THE GLASS TOUGHENED?**

A. The glass is tempered (toughened) to the latest European specs. Should it break, it does so safely in thousands of little pieces.

**Q. CAN I HAVE MY OWN DESIGN?**

A. Within reason yes, we can even print your photo on the doors (hi res photo needed though).

**Q. WHAT ABOUT HANDLES?**

A. Take a look at our web site...

**Q. WILL THE DOOR DROP DOWN OVER TIME?**

A. Our 10mm brackets have special cut outs ensuring it is impossible for the door to drop.

# WHAT ABOUT

## A BIT OF SERVICE THEN?

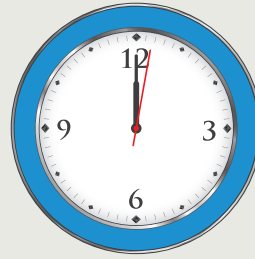

ORDER  
BEFORE  
NOON

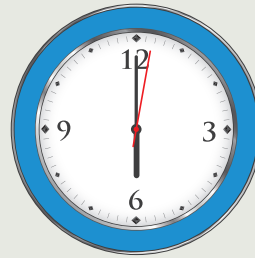

DELIVERY NEXT  
WORKING DAY  
NEXT DAY

...FOR ALL STANDARD SINGLE AND DOUBLE FRAMES WE AIM TO GIVE YOU A NEXT WORKING DAY DELIVERY IF ORDERED BEFORE 12.00 NOON ON A WORKING DAY

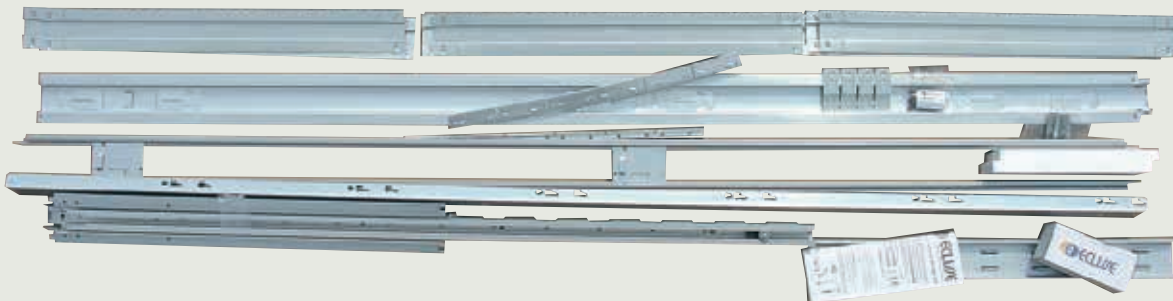

WE KEEP A COMPREHENSIVE RANGE OF SPARE PARTS IN STOCK SO IF YOU SHOULD LOSE A SCREW OR TWO ON SITE JUST GIVE US A **CALL ON 0845 4811977**, WITHIN REASON WE WILL SEND THEM FREE OF CHARGE.



DON'T SCRATCH YOUR HEAD IF SOMETHING'S NOT CLEAR, GIVE US A **CALL ON 0845 4811977** YOU WILL FIND A FRIENDLY VOICE THAT CAN HELP YOU WITH ANY ASPECTS OF OUR PRODUCTS. YOU CAN ALWAYS USE THE XR CODE TO GO STRAIGHT TO OUR INSTALLATION PAGES ON OUR WEB SITE.

At Eclisse we strive to be the very best in the business at all times, we aim to treat all of our customers with respect and honesty and ask the same from them.

If we can be of help or improve our service to you please do let us know.



**ECLISSE UK**

Richmond House 2 - Occupation Lane  
Gonerby Moor (nr. Grantham) NG32 2BP  
Tel 0845 4811977 - Fax 01476 560951  
Email: [info@eclisse.co.uk](mailto:info@eclisse.co.uk) - [eclisse.co.uk](http://eclisse.co.uk)